

Features

- Small Body Outline Dimensions:
0.60 mm x 0.30 mm
- Bidirectional ESD Protection of one line
- Low Clamping Voltage
- Working Voltage: 5 V
- Low Leakage Current

IEC COMPATIBILITY (EN61000-4)

- IEC 61000-4-2 (ESD) $\pm 30\text{kV}$ (air), $\pm 30\text{kV}$ (contact)
- IEC 61000-4-4 (EFT) 40A (5/50ns)
- IEC 61000-4-5 (Lightning) 5A (8/20 μs)



Mechanical Characteristics

- DFN0603-D package
- Molding compound flammability rating:
UL 94V-0
- Marking: Marking Code
- Packaging: Tape and Reel per EIA 481
- RoHS Compliant

Applications

- Cellular handsets and accessories
- Portable electronics
- Communication systems
- Computers and peripherals

Schematic & PIN Configuration

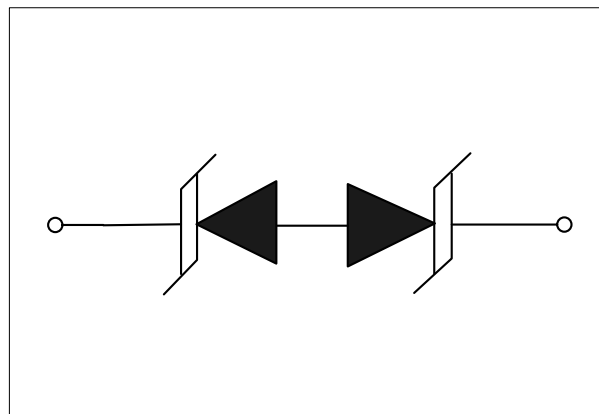

Absolute Maximum Rating			
Rating	Symbol	Value	Units
Peak Pulse Power ($t_p = 8/20\mu s$)	P_{PP}	90	W
Peak Pulse Current ($t_p = 8/20\mu s$)	I_{PP}	5	A
ESD per IEC 61000-4-2(Air)	V_{ESD}	± 30	kV
ESD per IEC 61000-4-2(contact)		± 30	
Operating Temperature	T_J	-55 to + 125	$^{\circ}C$
Storage Temperature	T_{STG}	-55 to +150	$^{\circ}C$

Electrical Parameters (T=25°C)

Symbol	Parameter
I_{PP}	Reverse Peak Pulse Current
V_C	Clamping Voltage @ I_{PP}
V_{RWM}	Working Peak Reverse Voltage
I_R	Reverse Leakage Current @ V_{RWM}
V_{BR}	Breakdown Voltage @ I_T
I_T	Test Current
V_{PT}	Punch-through Breakdown Voltage @ I_T
V_{SB}	Snap-Back Voltage @ I_{SB}
I_{SB}	Snap-Back Current

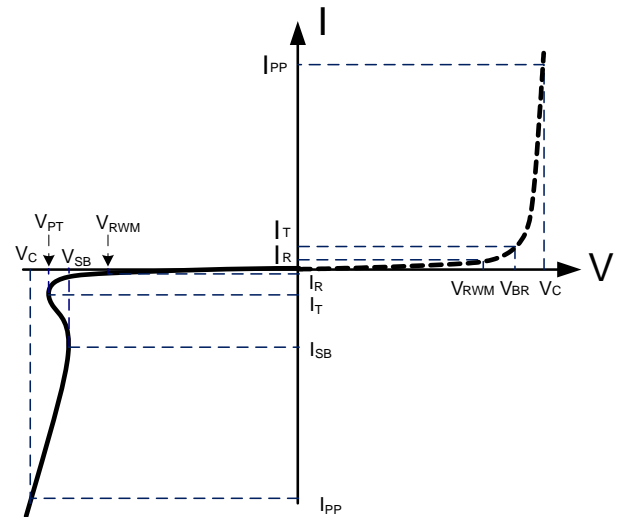

Electrical Characteristics

DW05DS-BA-01-E						
Parameter	Symbol	Conditions	Minimum	Typical	Maximum	Units
Reverse Stand-Off Voltage	V_{RWM}				5.0	V
Reverse Breakdown Voltage	V_{BR}	$I_T=1mA$	6.0			V
Punch-through Voltage	V_{PT}	$I_T=1mA$	7.0			V
Snap-Back Voltage	V_{SB}	$I_{SB}=50mA$	5.6			V
Reverse Leakage Current	I_R	$V_{RWM}=5V, T=25^{\circ}C$			50	nA
Clamping Voltage	V_C	$I_{PP}=1A, t_p=8/20\mu s$			9.5	V
Clamping Voltage	V_C	$I_{PP}=5A, t_p=8/20\mu s$		13	15	V
Junction Capacitance	C_j	$V_R=0V, f=1MHz$		6		pF

Typical Characteristics

Figure 1: Peak Pulse Power Vs Pulse Time

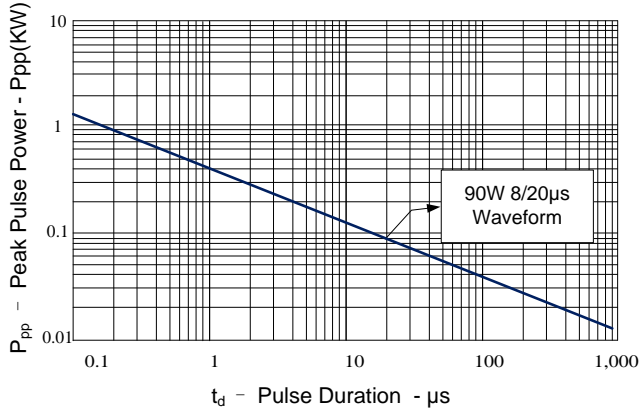

Figure 2: Power Derating Curve

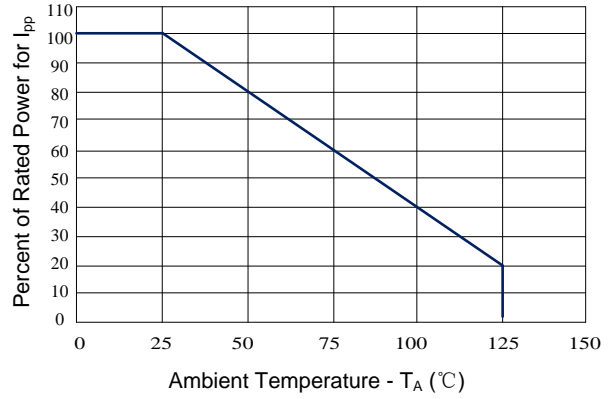

Figure 3: Clamping Voltage vs. Peak Pulse Current

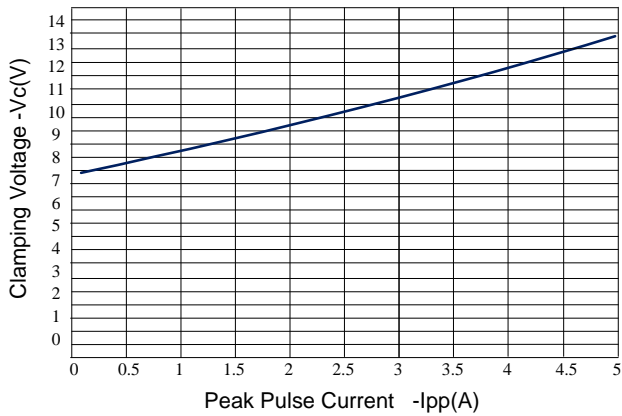

Figure 4: Normalized Junction Capacitance vs. Reverse Voltage

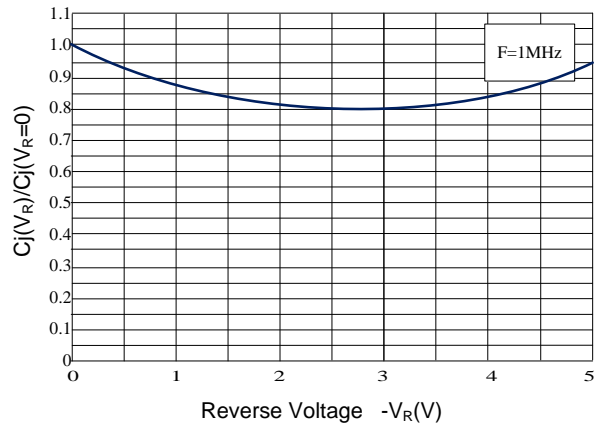

Figure 5: Pulse Waveform

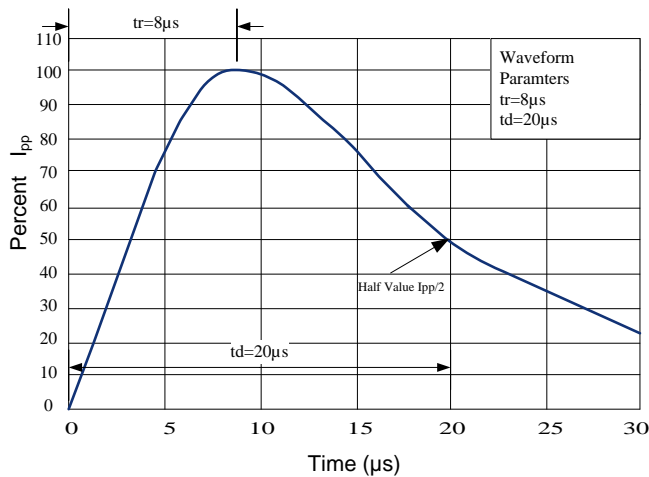
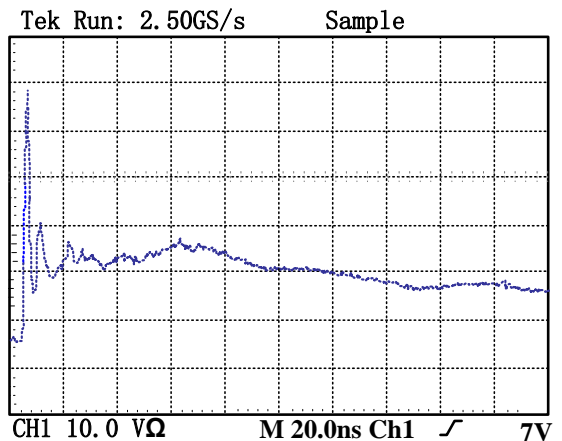
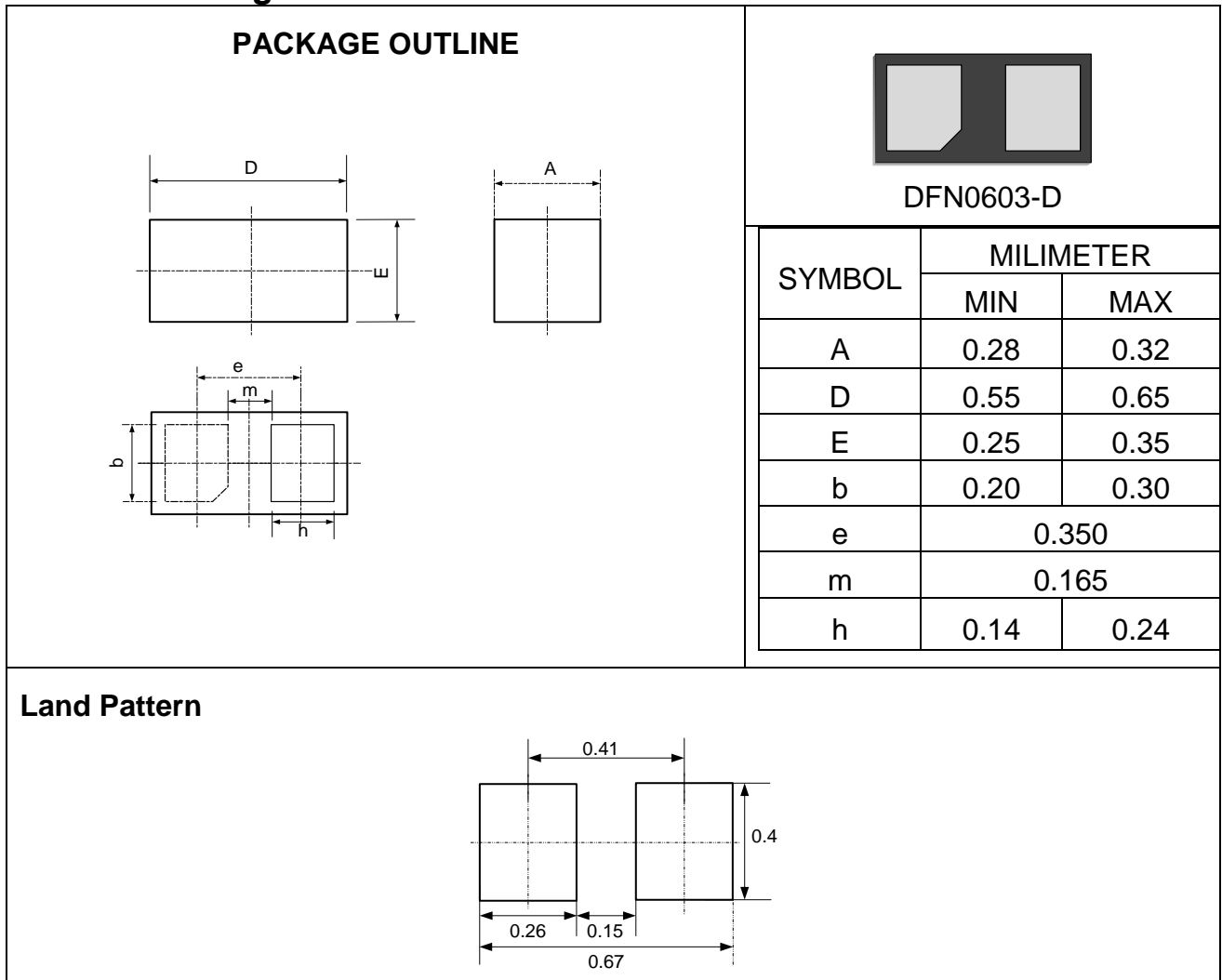

Figure 6: ESD Clamping(8kV Contact per IEC 61000-4-2)



Outline Drawing –DFN0603-D



Land Pattern

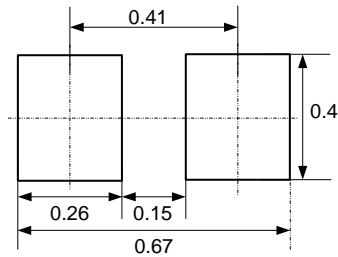

Marking Codes

Part Number	Marking Code
DW05DS-BA-01-E	<p>A = Specific Device Code M = Month Code</p>

Package Information

Qty: 15k/Reel